

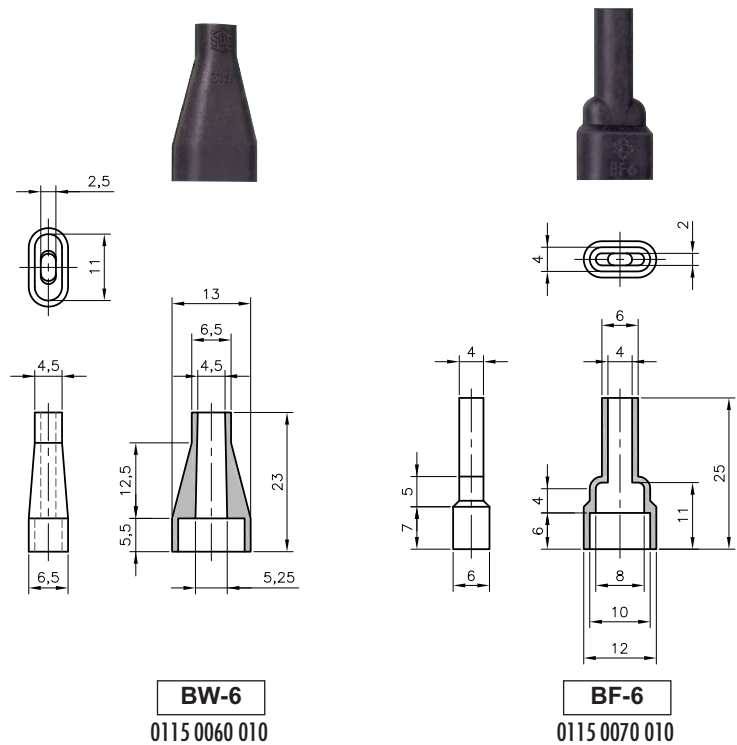

**• Izolační pouzdra (na zástrčku)**

Typ	Obj. č.	Na spoje	Kabel Ø mm	
<b>BW-6 TPE</b>	0115 0060 010	6,3	3,6	500
<b>BF-6 TPE</b>	0115 0070 010	6,3	3,6	500



**• Izolační pouzdra (úhlové zástrčky)**

Typ	Obj. č.	Na spoje	Kabel Ø mm	
<b>BE-6 TPE</b>	0115 0080 010	6,3	3,6	500

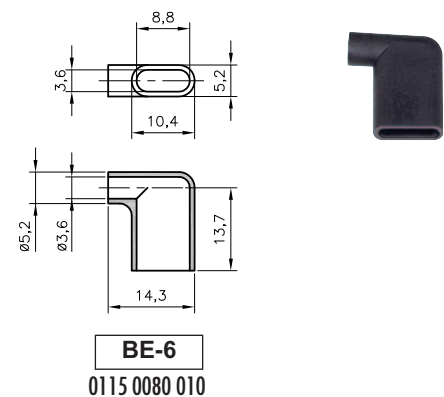

 D6/3-02 - Clips



# Izolační pouzdra PLIOPREN TPE

z Plioprenu TPE barva: černá



## PLIOPRENE TPE

-50 až +125°C



### • Izolační pouzdra (na přímé a pravoúhlé zástrčky)

Typ	Obj. č.	Na spoje	Kabel Ø mm	
B-TPE	0115 0010 010	6,3	4	500
B-3 TPE	0115 0020 010	2,8	2,8	500
B-4 TPE	0115 0030 010	4,8	3,2	500
B-5 TPE	0115 0040 010	5 AMP	4,5	500
B-6 TPE	0115 0050 010	6,3	3,6	500
BL-6 TPE	0115 0090 010	6,3	3,2	500
BK-6 TPE	0115 0100 010	6,3	3,2	500
BM-6 TPE	0115 0110 010	6,3	5	500
BN-6 TPE	0115 0120 010	6,3	5	500

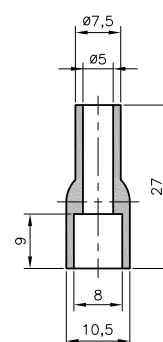
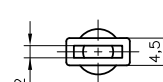
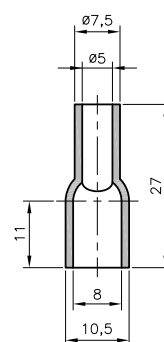
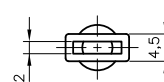
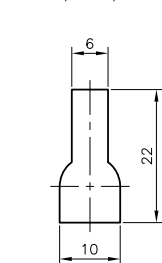
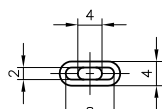
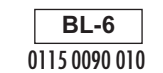
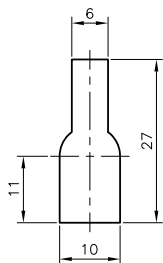
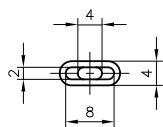
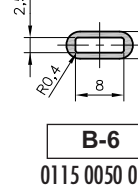
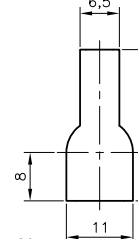
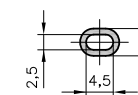
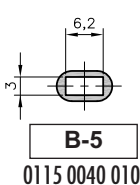
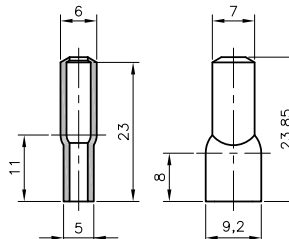
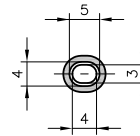
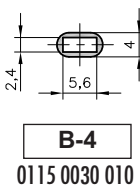
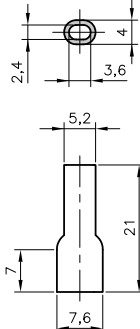
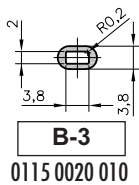
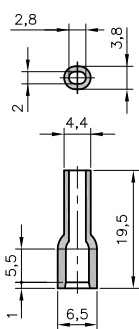
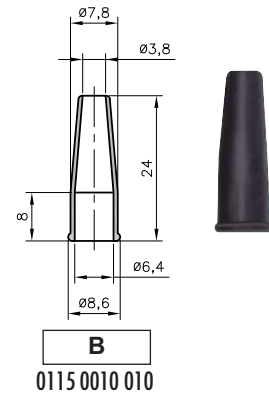

D6/3-02 - Clips

