

PLIOGRAPH^{PLUS}

Materiál: PVC
Barva: transparentní
Provozní teplota: -20 až +90°C

Použití: PLIOGRAPH^{PLUS} nosiče lze použít k označení kabelů pomocí PLIOGRAPH^{PLUS} kroužků a štítků, 14-1177 plátů M1P-M45 profilů.
 K dispozici v krabicích, v délkách 0,60 m pro řezání podle potřeby.



typ	obj. kód	Ø kabelu mm	max. znaky		kusy
			Typ 150	Typ 200	
Průhledný nosič délky 10 mm					
33-100	0365 0101 000	1,1 - 3,3	3	4	100
45-100	0365 0102 000	1,5 - 4,5	3	4	100
80-100	0365 0103 000	3 - 8	3	4	100
130-100	0365 0104 000	6 - 13	3	4	100
220-100	0365 0105 000	10 - 22	3	4	100
Průhledný nosič délky 18 mm					
33-180	0365 0111 000	1,1 - 3,3	6	8	100
45-180	0365 0112 000	1,5 - 4,5	6	8	100
80-180	0365 0113 000	3 - 8	6	8	100
130-180	0365 0114 000	6 - 13	6	8	100
220-180	0365 0115 000	10 - 22	6	8	100
Průhledný nosič délky 25 mm					
33-250	0365 0121 000	1,1 - 3,3	8	11	100
45-250	0365 0122 000	1,5 - 4,5	8	11	100
80-250	0365 0123 000	3 - 8	8	11	100
130-250	0365 0124 000	6 - 13	8	11	100
220-250	0365 0125 000	10 - 22	8	11	100
Průhledný nosič délky 32 mm					
33-320	0365 0131 000	1,1 - 3,3	10	14	100
45-320	0365 0132 000	1,5 - 4,5	10	14	100
80-320	0365 0133 000	3 - 8	10	14	100
130-320	0365 0134 000	6 - 13	10	14	100
220-320	0365 0135 000	10 - 22	10	14	100
300-320	0365 0136 000	13 - 30	10	14	100
Průhledný nosič délky 0,60 m pro označení vyžadující délky větší, než je uvedeno výše (dodáváno v boxu)					
33-0	0365 0151 000	1,1 - 3,3			45
45-0	0365 0152 000	1,5 - 4,5			28
80-0	0365 0153 000	3 - 8			18
130-0	0365 0154 000	6 - 13			12
220-0	0365 0155 000	10 - 22			6
300-0	0365 0156 000	13 - 30			3

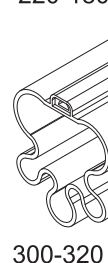
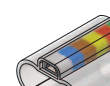
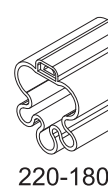
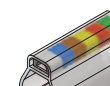
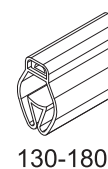
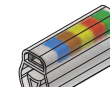
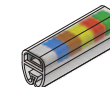
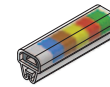

B5/2-01



B5/2-03



B5/2-04



B5/2-04

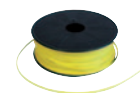

PLIOGRAPH^{PLUS}

Materiál: PVC
Barva: transparentní
Provozní teplota: -20 až +90°C

Použití: PLIOGRAPH^{PLUS} nosiče lze použít k označení kabelů pomocí PLIOGRAPH^{PLUS} kroužků a štítků, 14-1177 pláty M1P-M45 profily.
 Tento dvojitý systém umožňuje oboustranné značení.

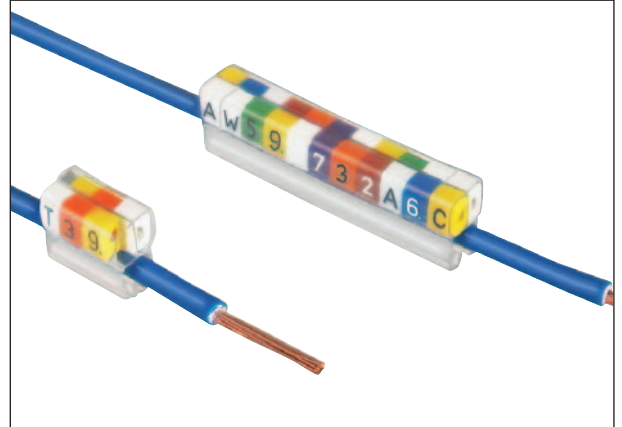

typ	obj. kód	Ø kabelu mm	znaky		kusy
			Type 150	Type 200	
Transparentní nosiče délky 10 mm					
45D-100	0365 0302 000	1,5 - 4,5	2x 3	2x 4	100
80D-100	0365 0303 000	3 - 8	2x 3	2x 4	100
130D-100	0365 0304 000	6 - 13	2x 3	2x 4	100
220D-100	0365 0305 000	10 - 22	2x 3	2x 4	100
Transparentní nosiče délky 18 mm					
45D-180	0365 0312 000	1,5 - 4,5	2x 6	2x 8	100
80D-180	0365 0313 000	3 - 8	2x 6	2x 8	100
130D-180	0365 0314 000	6 - 13	2x 6	2x 8	100
220D-180	0365 0315 000	10 - 22	2x 6	2x 8	100
Transparentní nosiče délky 25 mm					
45D-250	0365 0322 000	1,5 - 4,5	2x 8	2x 11	100
80D-250	0365 0323 000	3 - 8	2x 8	2x 11	100
130D-250	0365 0324 000	6 - 13	2x 8	2x 11	100
220D-250	0365 0325 000	10 - 22	2x 8	2x 11	100
Transparentní nosiče délky 32 mm					
45D-320	0365 0332 000	1,5 - 4,5	2x 10	2x 14	100
80D-320	0365 0333 000	3 - 8	2x 10	2x 14	100
130D-320	0365 0334 000	6 - 13	2x 10	2x 14	100
220D-320	0365 0335 000	10 - 22	2x 10	2x 14	100
300D-320	0365 0336 000	13 - 30	2x 10	2x 14	100

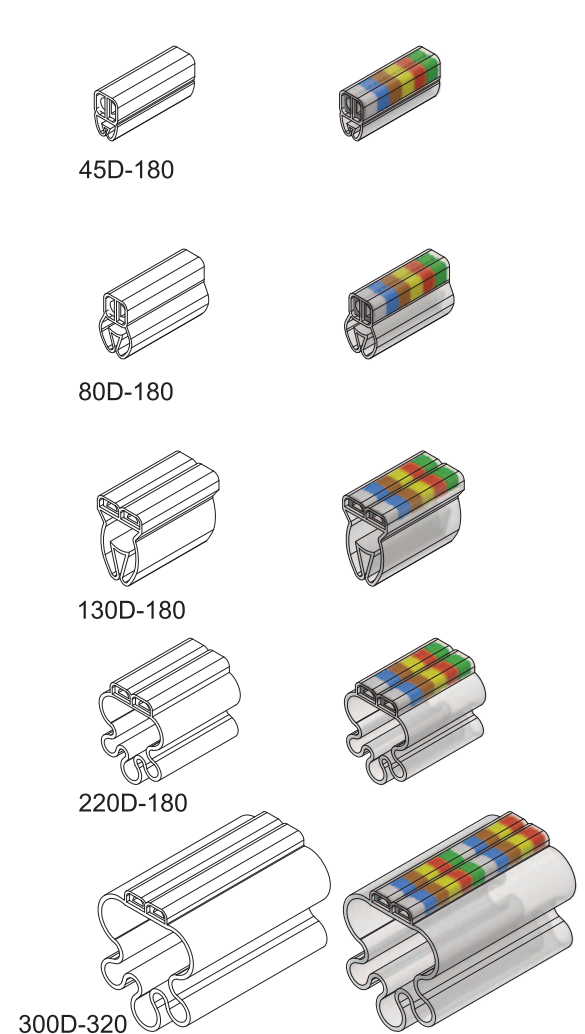

B5/2-01



B5/2-03



B5/2-04



B5/2-04

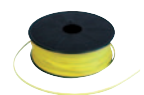

Nosiče série PR a PRA



PLIOGRAPH^{PLUS}



PR

Materiál: EVA 
Barva: transparentní
Provozní teplota: -10 až +65°C
Specifikace: bezhalogenové

Použití: Konstrukce těchto nosičů PR je taková, že značení zůstává vždy rovné, i když je kabel ohnutý na výstupu z připojení. Jsou pro dráty a kabely od 1 do 9 mm Ø.



typ	obj. kód	Ø kabelu mm	znaky		délka L mm	 kusy
			Typ 150	Typ 200		
PR 30-17	0373 0910 000	1 - 3	6	8	17	100
PR 30-22	0373 0911 000	1 - 3	7	9	22	100
PR 50-17	0373 0912 000	2 - 5	6	8	17	100
PR 90-17	0373 0913 000	4 - 9	6	8	17	100

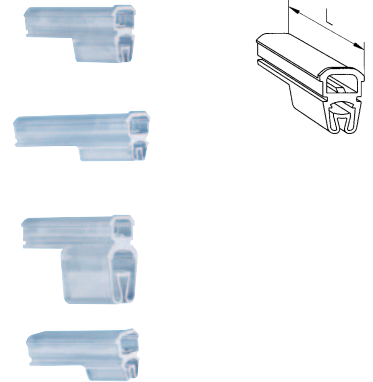

PRA

Materiál: PVC
Barva: transparentní
Provozní teplota: -20 až + 90°C

Použití: Popisovací nosič PRA pro značení kabelových svazků a trubek velkého průměru. Připevněno sponami o šířce menší než 7 mm.



typ	obj. kód	znaky		délka mm	 kusy
		Typ 150	Typ 200		
PRA 20-6	0373 0930 000	6	9	20	100
PRA 40-12	0373 0931 000	13	18	40	100

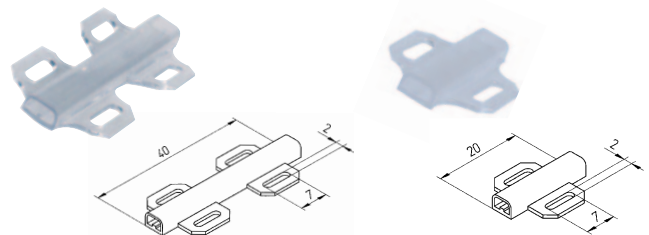

 B5/2-01



B5/2-03



B5/2-04



B5/2-04

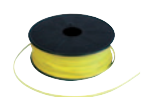

PRB

Materiál: PVC
Barva: základna: bílá
 držák: transparentní
Fixace: oboustranná lepicí páska (součástí)
Provozní teplota: -10 až +65°C
Použití: lepicí nosiče pro značení sloupek, potrubí, zařízení atd.



typ	obj. kód	znaky		délka L mm	 pces
		Typ 150	Typ 200		
PRB 10-3	0373 0932 000	3	4	10	100
PRB 18-5	0373 0933 000	6	8	18	100

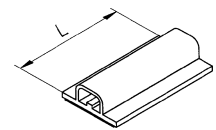

B5/2-01



B5/2-03



B5/2-04



B5/2-04



PRC

Materiál: PVC
Barva: základna: bílá
 držák: transparentní
Provozní teplota: -30 až +70°C
Instalační teplota: > +10°C

Použití: Nosiče PRC mají tuhou část pro upevnění a zajištění kabelu a průhlednou flexibilní část pro vkládání značek.

Skládají se ze dvou pouzder pro dvojité značení, před nebo po spojení se zárukou dlouhodobého držení uzamykacím systémem.

Jsou k dispozici ve 2 délkách a lze je použít k identifikaci kabelů od Ø 0,5 do 3,1 mm.

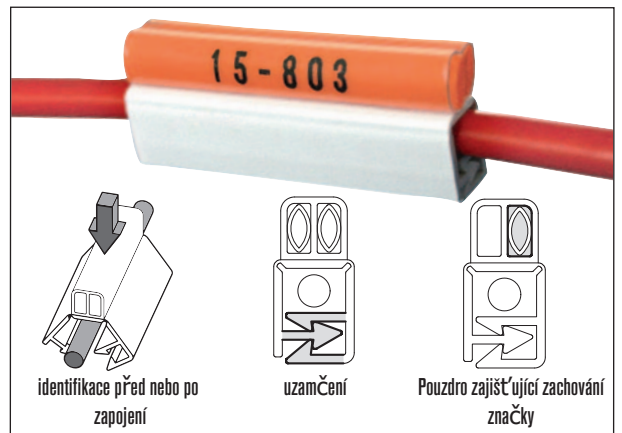

typ	obj. kód	Ø kabelu mm	délka L mm	 kusy
PRC 32	0377 0802 000	0,5 - 3,1	32	100

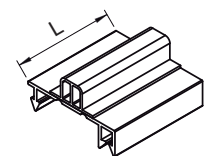

B13/21-01



B5/2-04



B5/4-01

